



*O Devi Saraswati,  
the most Auspicious Goddess of  
Knowledge with Lotus-like Eyes,*

*An Embodiment of Knowledge with Large  
Eyes,*

*Kindly Bless me with Knowledge,*

*I salute you...*



Dated 15<sup>th</sup> May, 2015

## **MESSAGE**

It is a matter of immense pleasure to know about the publication of the 8<sup>th</sup> edition of the University magazine 'Vartika'. Over the years it has evolved a full fledged magazine of the university providing a platform to our young budding technocrats to share their vision and ideas on themes ranging from natural calamities wreaking havoc around the world to India's Mars orbital mission and much more. Vartika has now become a symbol of hard work and flair of the student community and the faculty members associated in its creation.

I extend my heartiest congratulations and best wishes to the editorial team for their endeavor in bringing out this amazing edition of Vartika.

**Manoj Gaur**  
Executive Chairman

# JUET Events ... 2014-15

2014-2015, this was a session of expanding horizons for the University. From the revision in examination and evaluation patterns, to the expansion of the academic block, the changes have proven to be very good for the academic structure of the University.

The entire academic year was busy with events under the initiative of JUET Youth Club. Under the cultural wing, major events like El Partido Grande De Freshers, Retromania, the annual cultural festival D'Equinox, and finally the farewell ,i.e. Adios were organized. The JYC Literary Wing organised various quiz based events, debates, English Play(My Fair Lady), Model United Nations and Jaypee Youth Concord which witnessed a huge participation from other colleges as well. Dumb Charades ,Fukrey, Filmology and many more fun-filled events were organized by the JYC Art and Event Management Wing. The Media wing also remained active throughout the year. Under the Sports wing, the events organized were : Inter Year Leagues for basketball, football and badminton from November 10-24 2014. 'Run for Unity – Marathon' was organized in the campus on the occasion of Sardar Patel Jayanti. Blood donation camp was organized.

The Student Branch of Computer society of India, actively worked throughout the year, conducting events like Rapid Fire Sept 29,2014, C workshop Nov 2-7,2014, Trace it Out Nov 10,2014, Pictionary Nov 17,2014 , Web Designing Workshop Nov 20-24,2014. . In order to promote women in IT sector, JUET Firefox Club inaugurated WoMoz (Women in Mozilla) community in JUET. For the first time, CSI collaborated with the Mechanical Engineering Society (MES) of JUET to bring "Tachyon 2015", the annual technical festival which was held on 15th – 17th May, 2015, wherein various technical and fun events were conducted. The major attraction was the Mozilla FireFox App Development Workshop .



DEXTRA-2015 (National level Technical fest on May 1-3,2015) ,organized by the department of Electronics and Communication Engineering under the banner of ISF (IETE Students Forum), the department of Civil Engineering under the banner of CEF was a huge success. The 3 day mega fest, included within it brand new ideas, innovations and workshops for students. ISF also conducted the following technical events during this period:- Tech Charades September28, 2014, Arsenal October 30, 2014 and Tech Corporate January 30, 2015.

Nineteen students from B.Tech. Mechanical Engineering Department achieved 13th Rank in the finals of the National Go-Kart Championship held in Bhopal and Indore, January 23-25, 2015. Rajat Garg (Er no. 131855) and his group won the first prize in the event Maglev at IIT Kharagpur, January 30-31, 2015.

A National Workshop on "Advancements in Network Communication and Security (ANCS-2014)", was organized by Department of Computer Science & Engineering. A one day workshop on the theme of "Electronics System Design and Manufacturing" was organized by Department of Electronics & Communication Engineering.

Ms. Seema Singh, Ph.D. scholar, Department of Chemistry, presented a rd poster at the 3 Water Research Conference, Shenzhen, China organized by Elsevier. Dr. Vipin Tyagi, Dept. of CSE, has been elected as Vice President - Computer Society of India for Region Madhya Pradesh, Gujrat and Rajasthan.

Talking about the training and placements for the academic year 2014-15, 449 students are already placed. Shivam Singh Rana, a 4th year B. Tech. CSE student grabbed the highest package ever in college, ₹ 22 LPA (+ ₹ 2 lakhs at the time of joining), in a startup named "CodeNation". Around 40 companies have visited JUET for recruitment process 2015 batch. Among them companies like Infosys, Cognizant , Wipro, NEC Technologies, Magic Software, IBM, Aricent, Vinsol, Naukri.Com, APAC Sourcing Solutions ILtd., NTT Data, Continental Automotives have offered 381 students.



# LITERARY WING



"The purpose of Literary Wing is to entertain, inform, challenge, and get people to think about the worlds we inhabit and mind spaces we occupy" Believing that the "pen is mightier than the sword", the literary wing attempts to harness, discover and foster the literary talents of students through efficacious events all throughout the year like G.K. Quiz in which intelligence of the participants is judged depending on their general knowledge and awareness about the current affairs. Also the wing organizes debates, extempore and youth parliaments. The Debating Club regularly hosts many activities like group discussions and other interesting activities that enhance your speaking skills. This year the Literary wing also organized MUN-Model United Nations for the first time in JUET . It was a great success as it witnessed a huge participation and was really a memorable experience. Veritas, the theatre club conducted an English Play- "MY FAIR LADY' which received a lot of appreciation. There were also fun filled events organized by the wing during college fest were like Name Place Animal Thing, Connected, Guess Who, English Tambola, Alfaaz, etc and all were a great success where participants really enjoyed a lot. The hunt for Mr. and Miss. D' equinox - the most grand title of the university is conducted by Literary Wing which consists of a written round , then an extempore and finalists are selected based on their performance in personal interview. Jaypee Youth Concord was a new feather in the cap of the Literary Wing. A Youth Parliament with participation from over 10 institutes across the country, was the first ever conference debate organized in JUET. The conference simulated Lok Sabha and Rajya Sabha, with over 200 Parliamentarians debating. The club also publishes the Annual Magazine of the University-'Vartika' and the official newsletter 'The Observer' The Literary Wing teaches teamwork and enhances speaking skills, develops confidence and it is for classes not for masses.It has always been the cradle that groomed the talents, a platform conducive for nurturing talents in today's students of technology

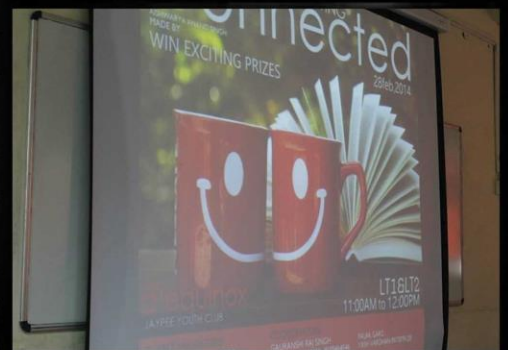

# CULTURAL WING



JYC Cultural wing gives the students a chance to unleash their talent on stage. "They won't laugh at you for being coal in a crowd full of pearls and rubies. They would not question your shine and clust. They would simply know that there is a DIAMOND in the making..."

The beginning of this session was marked by an important event to break the ice between the freshers and the seniors i.e. El Partido Grande de Freshers. All the first year students were given an equal chance to unpack their bags of talent which they managed pretty well.

The fresher's night had dance (solo, duet and group), music (solo and duet), drama and ramp show which was followed by the announcement of titleholders for Mr. and Miss. Fresher.

DJ night was another big event which turned out to be very successful as it had the whole college bounce up on their feet with endless energy. The college also witnessed a flash mob performance for the first time.

Retro Mania was another dancing event for all the bollywood lovers. We relived the era of shimmery outfits, leather boots, polka dots, bell bottom pants, dramatic dialogues, melodious songs and cool dance moves.

D'equinox, the cultural fest was the most awaited event, its entire responsibility was on the Cultural Wing. It included dance (solo, duet and group), music (solo, duet and group), drama and ramp shows which witnessed huge participation and was well applauded by the audience.

The Cultural Wing in its last event of the year, organized the annual Musical Night. It was organized in Jay Jyoti School's compound, where several students from all years flaunted their talent with their voice or instruments.



# VISIO CREATRIX

(The Media Wing)



Digital single-lens reflex fitted with a 35mm format image sensor in hands, with the stack of memories in it, an eye for nuance to click, love for the lights, heads full of picturing odds look even, the ideas of making one smile for another and another for one, this carriage makes them one of the most unique section of JYC.

JYC media wing is divided into four major sections namely Designing, Videography, Photography, Acting and Short film making. Contribution of equal creativity makes them a pillar of JYC.

From the beginning they have captured every nitty-gritty. With the steps of enthusiasm and interest, juniors walked in the world of media wing in October and at the same time the 'FOURTH YEAR Diaries' took all the memories of the seniors, who weaved this CLUB and shared their paths they made them stars and Dis Pics 2.0 convinced many to become Mr. and Ms. FLAWLESS

AD-Making brushed everyone's videography and designing skills.

Presence of Media Wing in D'Equinox 2k15 makes history for every one out there. The events like Lolfie started with the sense to extol and the events like Click-O-Word, Its your Fest which demanded spotting and the attention skills, on the other hand, Sketch The Match and Sensor accelerated ones creative sections of brains and last but not the least Get weird is the most awaited event which brings out all the nuts and funny faces. It urges people to get weird with a character they sustain in them but its virtual most of the times.

With the end of the this year we promises not let this air of photography to escape in any corner of the college but will keep its presence intact. And with innovations we will bring different ways to make your smiles.



# ART & EVENT MANAGEMENT

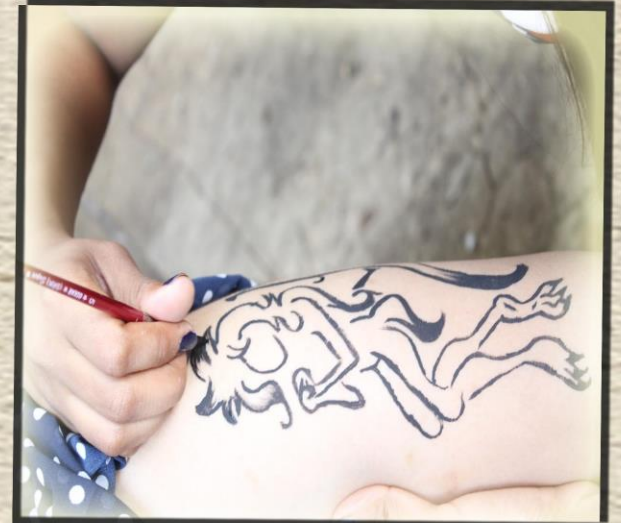

"Art no longer is the perfect aesthetic representation of life , but a personal expression of time and experience ". ART and EVENT MANAEMENT WING is the most creative, the most innovative and the most adventurous club of the college where ingenious minds are nurtured and ample of opportunities are provided to develop talents in different forms of art. The club focuses creativity, learning, laughter and freedom of expression! It is basically about being inventive, thinking out of the box and polishing your event management skills.

The wing started off with ambitious ideas, some of which came to fruition like starting the 'Hobby Club' which was held weekly and included activities like origami, glass painting, doodle making, best out of waste and many more.

Many blithesome events were organized by the wing throughout the year like Dumb Charades, Antakshari, Filmology, Tambola and Fukrey. Movies were screened in Box Office to enliven the atmosphere and revitalize the students after the hectic schedule of the academics. During festivals, many pleasure -seeking events were organized like Takeshi's castle, Tug-of-War, Minute to win it, Kalakriti, Hair and Face painting, Tatoo making, Treasure Hunt and the most thrilling Survivor 2.0

The marvellous decorations under the theme of 'Superheroes versus Villains' and 'The Medieval Times' left everyone mesmerised. Artistic talent was beautifully depicted by 'Sand Art' and 'Speed Painting'.

All in all this club polishes your management skills, brings out the imaginative ideas and develops leadership and teamwork.



# SPORTS WING



We all came here with the hopes to fly. Wings spread wide for the gusts of wind coming by, with passion in heart and a view set high. Looking for inspirations and the right place to try.

And try you can, all you want for, here at JUET we have a full fledged youth club to support your every endeavor with a hope to flourish; and an integral part of our JYC is the sports wing, for those who like to have a pace.

The sports club support and coordinates daily practices of a large number of games like basketball, volleyball, football, handball, badminton, table-tennis, lawn tennis and cricket. With a flurry of practices going on and off field every morning as well as in the evening, the sports field becomes the most happening place to be at between 6pm to 8pm.

To reward efforts of our players and to encourage their spirit we organize annual Inter-year leagues witnessing high energy matches between inter year sports team. The enthusiasm of the players and even the crowd, usually cheering their throats out, is highly infectious and with half the college supporting you what more can one ask for as a perfect platform to show their talent and hard work.

Even the faculty has proved to be a pillar of strength. Their interest in sports is overwhelming. Students take a great pride in sharing the field with their mentors.

The sports wing this year took great pride in organising fun events in the annual cultural fest of this college D'EQUINOX. Events such as futsal, foot-tire, dart and foot-volley were very popular among a large number of people in the college. The sports wing always wishes to provide the students a healthy and fun way to channelise their energies.

If life does not seem to offer a game worth playing, then invent one. For it must be clear to the most clouded intelligence, that any game is better than no game.





# Computer Society of India

## Student Branch, JUET

The Student Branch of Computer Society of India at Jaypee University of Engineering and Technology is a team of enthusiastic and high aiming students of the University with the common objective of motivating students to increasing their sphere of knowledge in the broad area of Computer Science. The Student Body Council of CSI at JUET is the only body that carries out Computer Science related events in the college throughout the year. This Student Body is mainly composed of four clubs -- namely Programming, Web-Tech, Multimedia and Publication -- which carry out activities in their respective domains. The academic year of 2014-15 saw CSI, JUET's website <http://www.juet.ac.in/Others/CSI/Index.html>, which is featured on JUET's official website, brought into existence by its website development team.

### ***Description of Existing CSI, JUET's Clubs:***

#### THE PROGRAMMING CLUB

The Programming Club of CSI, JUET is responsible for carrying out activities related to the popular field of Computer Programming. The club, with an aim of creating and increasing the interest of students towards coding, has been organising an Online Programming Contest called "KodeAthon" since early 2013. In addition to having organised workshops on basic topics such as C, JAVA and Data Structures, the club's resolve made it possible for the University's teams to qualify for the prestigious ACM-ICPC Regionals. The year of 2014 saw 5 teams qualifying for the Regionals: 1 for Kanpur, 1 for Kharagpur, and 3 for Amritapuri.

#### THE WEB-TECH CLUB

Web designing is a relatively new discipline within the design field requiring a combination of skill in visual design and proficiency with technology. CSI, JUET's Web-Tech Club is focused on helping students learn the new and much-needed skill. The Club has organised a workshop on HTML/CSS and PHP and has also been organising an Online Treasure Hunt where deduction skills of the contestants are judged on the basis of several graphical clues, the portal of which are designed by the club's own members! CSI saw other events from the Web-Tech club including Online LAN competition and



## THE MULTIMEDIA CLUB

In our increasingly technological world, literacy involves media literacy, i.e., the capacity to be conversant with various forms of media, and the ability to employ these media to express oneself. The Multimedia Club of CSI, JUET, thus provides a platform for students to exploit their creative instincts. With that goal, the club organised a 3-day Graphics Designing Workshop, motivating students learn Photoshop and CorelDRAW to the desired level. Other events of the club comprised the fun-filled Facebook Maniac, Pictionary and Creative Desktop.

## THE PUBLICATION CLUB

An event cannot be successful without proper publicising and promotion. Hence, Publication Club was brought into being in 2013 with the main motive of eliminating ignorance of the events of CSI, JUET. Chores of the newly-formed club range from the production of notices and pamphlets to large-sized banners. Other important tasks of the Club include maintaining an event calendar every semester and making instant, written records, or Minutes of Meeting, of every official CSI gathering.

## GOOGLE STUDENT COMMUNITY

The Google Student Community (GSC) has been recently formed in JUET in association with CSI. For the first time, a Google Student Ambassador has been chosen by Google from JUET. GSC is responsible for conducting events and workshops related to the products of Google and motivate students to use them. GSC recently organised an extensive Android Development Workshop in association with CSI and Google Developer Group, Indore. Other events from GSC included Google AdMob, Google Cloud Developer Challenge, Do the Doodle, and Clickathon.



# Mechanical Engineering Society

"At their best, and at their most creative, science and engineering are attributes of liberty— the noble expression of man's God-given right to investigate and explore the universe without fear of society or politics or even religious repressals".

From Optimus prime to Bugatti Veyron everything is built around Mechanical engineering. Its one of the oldest and most prestigious fields of engineering.

Innovation and inventions are two words that defines the brain of a mechanical engineer. Being in such field already gives you a royal feeling and its royalty is maintained by MES in our University. MES is the sole responsible organization for conducting core mechanical events in university. It has already proved its worth after organizing TACHYON, an annual tech fest, and super hit events like Pascal's logic, Automobile quiz & Automobile workshop, and Quad Rotor Workshop.

Events like Pascal's logic judged the student's brain power from drawing a prototype picture to creating the actual working crane purely working on hydraulics. From lifting to rotating everything was challenging enough, more over with restrictions like rotating more than 90 degree lifting a trash can it really became challenging.

Automobile quiz was really a tedious job to finish. Automobile quiz taught automobiles is never ending well of knowledge the deeper you go the deeper you learn. Automobile club, Production club, & technical club comes under it which concentrates on educating students about various disciples of mechanical field and its industrial benefits.

It is run by Dr. Bhagat Singh as its President, and Dr. Yashwant Modi as the Faculty Advisor; and a student body which was selected from 1-4years through interviews, under the leadership of Pratyush Vaibhav as the Chairperson

MES is the society which not only educates but it transform students into a professional engineer.

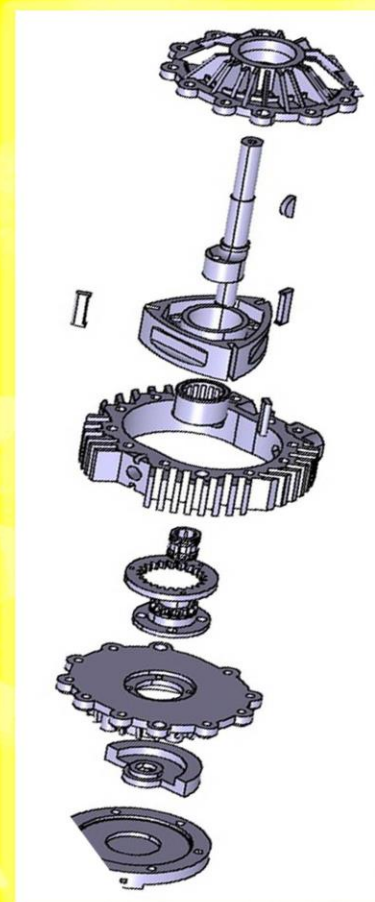



# CIVIL ENGINEERING FORUM

## Inquisitive Souls & Concrete Goals

The foundation of Civil Engineering Forum was laid on April 5th, 2012 with the aim of creating inventive and ingenious civil engineers by providing a platform to the students that stimulates a passion for learning in them. A magniloquent inauguration ceremony was held on 18th April, 2012 marked by the presence of Prof. K.K.Jain (Dean - Academics) as Chief Advisor, Prof. N.J.Rao (Vice Chancellor) and Dr. A.K.Mullick.

The forum commenced its activities under the guidance of Prof. N.J.Rao (Chief Patron), Prof. K.K.Jain (Patron) and our faculty advisors – Dr. N.K.Samaiya and Mr. R.K.Goliya. Mr. Anuj Agrawal (Student President), Mr. Alok Shekhar Pachauri (Secretary) were elected as the office bearers for the academic session 2014 -15.

Other committee members included the civil engineering students from 1st to 4th year who were selected on the basis of their personal interviews.

In the academic session 2014 -15, also CEF has conducted various successful events and received commendable participation and appreciation from the students as well as the faculty members. Major events were: Concrete Challenge, CAD, Truss It, Clay Modelling, Potential Prof, Green Media, Debate and many more.

“Success isn’t just about what you accomplish in your life, it’s about what you inspire others to do.” Following this mantra, CEF aims to create a sense of management and responsibility in the prospective civil engineers so that they set perfect examples in their respective fields in the society.



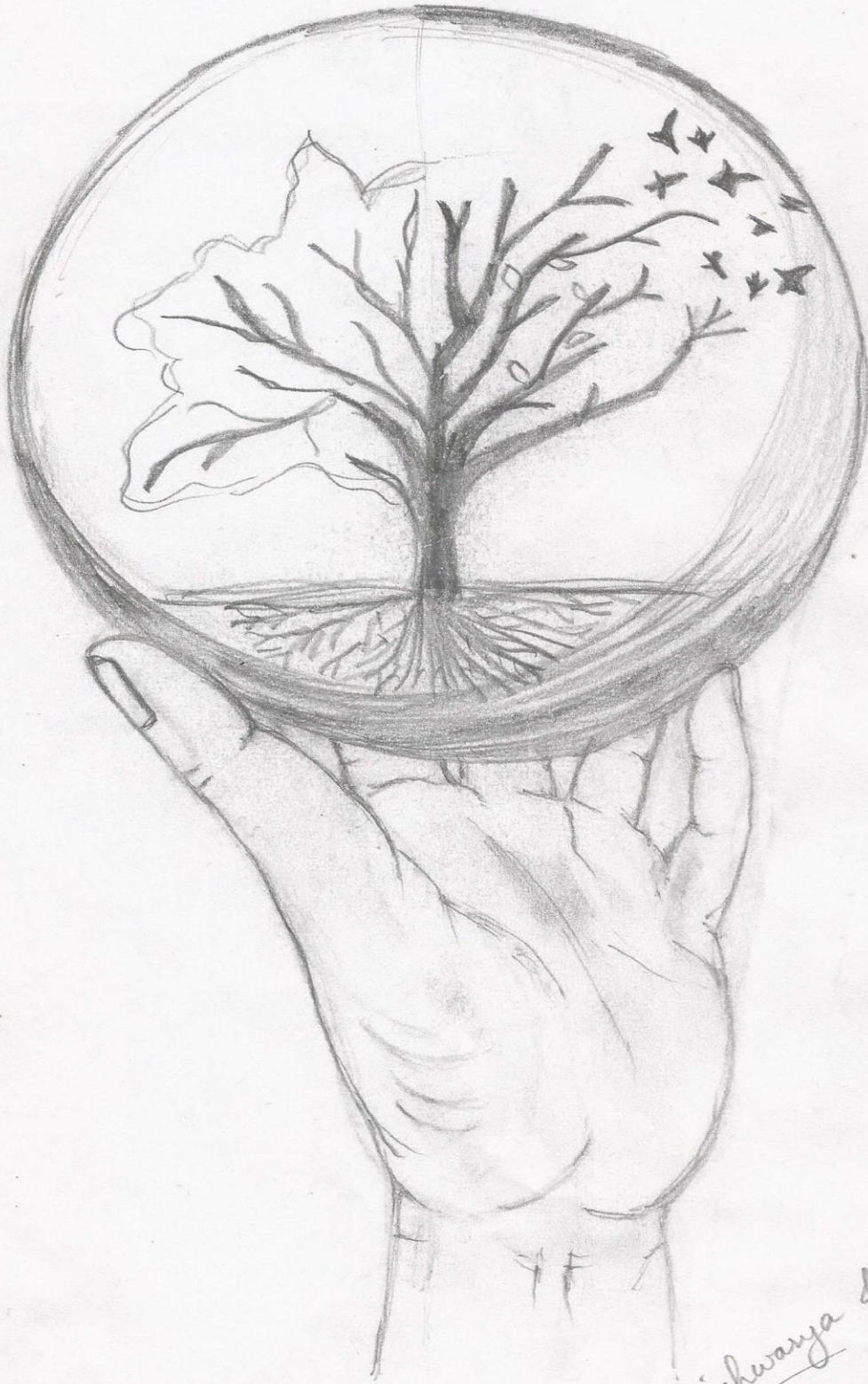

*Aishwarya Jayant*

Sketch by:  
Aishwarya Jayant  
2nd year, CSE

# W O R L D P E A C E

## A MYTH ?

'Which single invention could guarantee world peace?'

'Atom Bomb'

'What?'

'Drop atom bombs all over the world so there won't be a single man or a creature to create violence.'

In the words of His Holiness Dalai Lama, a Nobel Peace prize winner,

'When we rise in the morning and listen to the radio or read the newspaper, we are confronted with the same sad news: violence, crime, wars, and disasters. I cannot recall a single day without a report of something terrible happening somewhere.'

Religion, land, power, strategic positioning, natural resources, historical enmity, political posturing, nonreligious cultural conflicts, there is a never ending running list of reasons we could etch out to fight.

It seems like conflict has given us a sense of purpose. Most of the nations have been formed on conflicting ideologies. Communism Vs Capitalism, Democracy Vs Monarchy, Ethnicity and Language and not to forget one of the chief propellers, Religion.

These conflicting philosophies due to their very existence

make them impossible to correlate to each other's insecurity, grief and problems.

If organized terrorism was not enough, the advent of new technology has brought in a new threat, a digitally enabled freelance terrorist.

Inspired by Al-Qaida and ISIS, these leaderless 'lone wolves' are young, brutal and in a hurry to unleash mayhem. They may be children of digital age, but they do have grievances genuine or perceived and crave to give a violent expression to them.

Another alarming threat to world peace is the growing use of drugs. The former Soviet Union used the illicit drug trade as part of its strategy to destabilize targeted countries. Terrorist organizations have followed instructions religiously. For decades, organizations like the Revolutionary Armed Forces (FARC) in Colombia, the Maoist Sendero Luminoso (Shining Path) in Peru, and the Palestinian Liberation

Organizations (PLO), used the illicit drug trade as advised by the Soviet model. Now, the Popular Front for the Liberation of Palestine (PFLP), and radical Muslim Organizations like Hamas, Hizbullah, The Islamic Jihad, and plenty others have learned to use the drug trade for the exact same purposes.

In my opinion, world peace is a fiction, a myth if you don't consider it to be a relative term. We can never achieve it because people try to fight the symptoms, and do not understand the causes. Game theory is a large branch of science that analyzes these causes, by creating models of different interaction scenarios to find why and when some decisions are made.

One famous example of such models is Prisoner's dilemma in which cooperation is mutually beneficial, but each side can potentially gain more by betraying the other side. This is very similar to most interactions between countries - peace is mutually beneficial, but if your neighbor is not prepared for war and you are, then you might gain more by attacking him.

Addressing this question in beauty pageants, peace events can't tackle the issue. Maybe, contraception can reduce competition for resources. Disarmament of the countries is too utopian an idea to be successful. Considering Humanity as a religion above all might help a bit.

As has been said by Plato, *"Only the dead have seen an end to war", and this is the bitter truth.*

-Mehul Kulshreshtha  
III year, CSE



# KARTAVYA

Sukhmay jeevan kaa tyaag karo..  
 Aur badha ka sanghaar karo..  
 Angaare dharti mein bichein hain....  
 Chalkar unko paar karo....  
 Kaalchakra ka graas bano,  
 Usse pehle kuch karya karo..  
 Desh tumhare haathon mein hai..  
 Is desh ka tum udhaar karo..  
 Samasya jab aan padi ho..  
 Dheeraj se us par waar karo..  
 Uplabdhi haasil hone par..  
 Ehenkaar ka tyaag karo..  
 Sangharsh sheel tum bane raho..  
 Sangharsh ka tum deedar karo..  
 Athak parishram ko apnao..  
 Rakt me usko sanchaar karo..  
 Mrigtrishna jab kabhi satae..  
 Khud par tum vishwaas karo..  
 Sakri pagdandi saa jeevan..  
 Safal roop se paar karo..  
 Naitik moolyon ko tum apne..  
 Jeevan mein sweekarya karo..  
 Anaitikta mehsoos karo..  
 Tab daman tum uska waar karo..  
 Gujarti har shaam yahan hai..  
 Gujregi har shaam yahan..  
 Paschaat gujarti shaamon par tum..  
 Swa-manthan har baar karo..  
 Karo parishram bano udyami..  
 Fal chintan ka tyaag karo..  
 Asafal hone par bandhu tum..  
 Kabhi naa fir santaap karo..  
 Chalaymaan bas sada raho tum..  
 Haar ko naa sweekarya karo..  
 Veeron ki bhaanti date raho..  
 Aur lakshya pe apne ghaat karo..  
 Raah mein chalne se pehle..  
 Un maa-baap ko yaad karo..  
 Teevra gati se waqt gujarta..  
 Kartvya samarpan kaa sath karo..  
 Ishwar se vinti hoon karta...

-Divyesh Pratap Singh  
3rd year ,Civil



# Possibility at a stone's throw !

Over many centuries, world civilization has witnessed countless instances of warfare, battles, and conflicts duly capable of employing the power of transmuting the human kind into forms what the emperors and rulers had never thought of. There existed peerless and rarest men among the human species who preached and practiced theories of peace that made the human race to evolve into a more enlightened genre living of what it is today on this planet .

Taking an example, the Greeks have been considered to be noble people, generous in their offerings to the gods, trying to delay wars as much as possible. Very different as compared to the Romans who evolved a few centuries later and had a more war-like and disciplined approach in every walk of life. But the fundamental element in each civilization was, and will always be power. The Norse suffered the same fate when goddess Freya wandered into Asgard, lusting for fame and power. The war of Mahabharata, speaks of the tales of power, lust, fame and envy.

Ever since the dawn of time, power has been something that has kept man on his feet always. And the most obvious and easy way that appears to him to have control over things is War. And hence, history has registered several

wars, ranging across the centuries. The Golden age war, the Trojan war, the war of Aesir and Vanir and the Mahabharata have been some of the most violent and brutally fought wars, which resulted in total destruction and the civilization being wiped out.

In the words of Dalai Lama, "War is like a fire in the human community, one whose fuel is living beings." This analogy stands perfect in an uncanny way. Like the old saying goes, it takes two to clap. So it can be deduced that no war is possible without both sides losing their minds over what can be traced as a petty issue.

Going back to the Trojan War, which brew from a quarrel between the goddesses Athena, the goddess of wisdom and battle strategy, Hera, the goddess of marriage, family and prosperity and Aphrodite, the goddess of beauty and love. Eris, the goddess of strife and pain gave them an apple, which later came to be known as the 'Apple of Discord' meant for the fairest of them all. They were all sent to Paris, the prince of Troy as a plan hatched by Zeus, the king of Gods, who thought the Earth was becoming too crowded to be controlled. After Paris called Aphrodite the fairest of all, and earned the rage of the other two goddesses, Aphrodite made Paris fall in love with Helen, the queen of Sparta and asked them to elope. This later

led to a war between Troy and Sparta which lasted for more than a decade.

And even in today's world, surfing through the examples of 9/11, 26/11 and the recent Peshawar blasts that shook the core of humanity, a point can be clearly made that people driven by the madness for power and an unbeatable urge to seize control over others are usually the reason for increasing disturbances. Not to mention the Gulf war, US-Iraq war, the invasion in Syria, and the Kargil war along with countless others.

Talking about the Kargil war for a moment. The cause of the war was the infiltration of Pakistani soldiers and Kashmiri militants into positions on the Indian side of the LOC. Although in the beginning Pakistan made it clear that the war was just because of the independent Kashmiri insurgents, the later findings disclosed the involvement of Pakistani paramilitary forces.

So in simple terms, people have minute differences, then they exaggerate their noted points and in turn, insult the other side and then weapons make their way in. Technically, wars should be attributed to weapons. So, could disarmament be an answer?

It wouldn't be totally wrong to say that there hasn't been as increase in people's hatred as it had been in their ability to wield it into weapons. The ability to manifest their hatred into vastly destructive weapons has made it clear that peace is certainly out of reach with a nuclear bomb a stone throw away. The argument presented here is that weapons are used more for defensive purposes than offensive, and hence every country should have some weapons and should not fall for disarmament. True enough.

So obviously, disarmament isn't the best choice either. It is already difficult for people to keep their ego aside, and we are talking country level here!

Then what could it be? It seems that the idea of world peace moves further and further away as war continues to progress across the world and oil companies governing us. And at such times, altruism could prove to be an answer.

Altruism or selflessness is the principle or practice of concern for the welfare of others. The practice of compassion is not just a symptom of unrealistic idealism, but the most effective way to pursue the best interest of others as well as our own. The more we- as a nation, a group or as individuals- depend upon others, the more it is in our best interests to ensure their well-being. Practicing altruism is the real source of compromise and cooperation; merely recognising our needs for harmony isn't enough.

Perhaps practicing altruism, following the basic fundamental freedom and possibly ditching hazardous weapons may get us somewhere close to the ultimate goal of attaining world peace. And perhaps someday, peace and prosperity could coexist.

**Akanksha Srivastava**  
(3rd Year, ECE)

# The Millennium Development Goals

"The test of our progress is not whether we add more to the abundance of those who have much; it is whether we provide enough for those who have too little."

-Franklin D Roosevelt

Very well said by Mr. Franklin D. Roosevelt and clearly pictured the ongoing condition of world. One world is talking about nuclear weapons other talks about finding life on Mars but a few are trying to improve conditions on mother earth Still some people are giving their everything to help people in their fight with the poverty, education, equality and chronic diseases. The eight Millennium Development Goals (MDGs) – which range from halving extreme poverty to halting the spread of HIV/AIDS and providing universal primary education, all by the target date of 2015 – form a blueprint agreed to by all the world's countries and all the world's leading development institutions. They have galvanized unprecedented efforts to meet the needs of the world's poorest.

Out of the eight MDGs the very first one is

- 1.To eradicate extreme poverty and hunger.
- 2.To achieve universal primary education.
- 3.To promote gender equality.
- 4.To reduce child mortality.
- 5.To improve maternal health.
- 6.To combat HIV/AIDS, malaria and other diseases.
- 7.To ensure environmental sustainability.
- 8.To develop global partnership for development.

Although its very overwhelming that such works are being seriously taken by many countries but few countries are not even close to achieve any goal. South-eastern Asia is the first developing region to reach the hunger reduction target ahead of 2015. The proportion of undernourished people in the total population of the region has decreased from 29.6 per cent in 1990-1992 to 10.9 per cent in 2010-2012.

but the slowing of economic growth spells continued job losses, with young people bearing the brunt of the crisis. The number of unemployed people has increased by 28 million since 2007, and an estimated 39 million people have dropped out of the labour market, leaving a gap of 67 million people without jobs as a result of the global economic and financial crisis

Developing regions have made impressive strides in expanding access to primary education. From 2000 to 2011, the enrollment rate grew from 83 per cent to 90 per cent, and the number of out-of-school children dropped by almost half from 102 million in 2000 to 57 million in 2011. Achieving gains in education will have an impact on all MDGs.

But early school leaving remains persistent. Among the 137 million children who entered first grade in 2011, 34 million are likely to leave before reaching the last grade of primary school. This translates into an early school leaving rate of 25 per cent—the same level as in 2000. Gender gaps in access to education have narrowed, but disparities remain among regions in all levels of education, particularly for the most excluded and marginalized. Gender parity in primary schooling worldwide has been achieved. There has been major progress across all developing regions in reducing gender gaps in primary school attendance. However, girls continue to face barriers to schooling, particularly in Northern Africa, sub-Saharan Africa and Western Asia. Although more girls are now in school in sub-Saharan Africa, only 93 girls are enrolled in primary school for every 100 boys.

Gains have been made in child survival since 1990, making it possible to increase child survival for future generations. Worldwide, the mortality rate for children under five dropped by 47 per cent—from 90 deaths per 1,000 live births in 1990 to 48 in 2012.

The MDG target of halting and beginning to reverse the spread of HIV has been met. In addition a record 9.7 million people living with HIV were accessing treatment in 2012 compared to just over 8.1 million in 2011—an increase of 1.6 million in one year alone.

Global malaria deaths fell by an estimated 26 per cent from 2000 to 2010. More than half of the 1.1 million lives saved were in the 10 countries with the highest malaria burden.

More than 240,000 people a day—1.9 billion people—gained access to a latrine, toilet or other improved sanitation facilities from 1990 to 2011. The greatest progress has been made in Eastern Asia, where sanitation coverage increased from 27 per cent in 1990 to 67 per cent in 2011. However, a strong push is needed to increase this number globally by another 1 billion people by 2015. Stopping open defecation—a practice that poses serious health and environmental risks to entire communities—is a key factor in continued progress in sanitation.

The trade climate continues to improve for developing and least developed countries. The developing country share of world trade rose to 44.4 per cent in 2012. Average tariffs levied by developed countries continued to decline for developing countries in 2011.

Although the steps taken by the United Nations by implementing various policies have been successful to some extent but there still is a lot of room for development which can only be achieved by the world coming together and increased participation of individual countries.

*Hrishi Jain*  
(2nd Year, MEC)

# IS WAR A NECESSARY EVIL?

In peace, sons bury their fathers. In war, fathers bury their sons.

—  
-Herodotus

War such a simple three syllable word that most people don't give it a second thought but those who have fought in a war and lived to tell the tale know that such an unassuming word has mortifying consequences.

Our world hasn't been left untouched by war and its horrifying aftermath, but what is war? If you ask a scholar he will say that war is a state of armed conflict between autonomous organizations or coalitions of such organizations. If you ask a young enthusiastic man who has never taken a life he will say that war is where you serve your country where you fight to protect what is dear to you. If you ask a war veteran he'll say that war is HELL simple and blunt, war is where you either kill or be killed, war is where hundreds of young men lose their innocence, where they learn the harsh reality of life as they watch the life extinguishing from their enemy's eyes. However, an unbiased passive judge would say that war is a necessary evil.

We can pretend that we fight wars for the greater good of mankind but deep down we all know that we do it for our own purpose, be it the desire to fight or to do your country a service. We do it to fulfil our needs; we are sentient creatures as such we are bound by our

desires, our motivation, could be a need for security, a desire to prove ourselves or it could be as simple as love for blood and gore. War is rarely justified in a philosophical way that dispassionately considers the claims made by all the parties involved, rather the justification of war is guided by political authorities who make one sided arguments. Nations justify war to themselves in light of their own agendas; such justification is rarely neutral. The myths of patriotism guide such justifications. In the end it doesn't matter who was right or who was wrong because "History is written by victors". But war is needed as World War II no matter how devastating brought the world together it resulted in the formation of UN and NATION.

Though we have contained our urges for now, we must never forget the sheer destructive power we have at our fingertips. War is death and despair, war is broken families, war is genocide, war is a necessity, war is a necessary evil. War though traumatizing and catastrophic makes us stronger, more consolidate each time.

So many have died fighting for what they believed in, for what they thought was right perhaps it is our curse as sentient beings to eventually submit to our most basic urges. But may be just, may be their deaths were not in vain perhaps their deaths have a higher purpose that we can't

yet see, perhaps they were meant to die in war to remind us to fight our urges but until such a time comes when we can detach ourselves from our urges we will always need war to remind us what we are capable of and what we can achieve together. War is a necessary evil.

“You may say I’m a dreamer, but I’m not the only one. I hope someday you’ll join us. And the world will live as one.”

– John Lennon

For centuries, the world has been facing wars and witnessing the rise and fall of kingdoms. War brings with it destruction and chaos. The world has now come a long way from the age of old wars for land but the war for power remains. The modern age wars can be even more disastrous because with the advancement in science, the means of warfare has also improved. In such a situation, the need for world peace arises.

settle down issues that disturbed peace. They often fail to realize the fact that violence erupts at the social level, commutes to the political level and seeking a resolution finally at the military level. Diplomatic efforts have become more so customary and ineffective in front of military powers. The economic status of the nations too plays a crucial role in determining the degree of success of any peace initiative.

World peace is defined as an ideal of freedom, peace, and happiness among and within all nations and people. It generally includes an idea of planetary non-violence by which nations willingly cooperate, either voluntarily or by virtue of a system of governance that prevents warfare. Today, peace has predominantly become political work towards settlement of issues between the nations through military involvement, cessation of arms and weapons and dialogue on less-violent, civilian matters. Peace has also included some humanitarian efforts that stretch its helping hands to the calamity-hit regions in the world.

Nations must realize that peace can be achieved only through non-violent means, through dialogues and discussions rather than the show of military power. In the words of Mahatma Gandhi, “Peace will not come out of a clash of arms but out of justice lived and done by unarmed nations in the face of odds.” The rationale behind achieving peace is in the positive understanding of “give and take”, humanity, forgiveness, nonviolence and above all responsibility. The premise behind this idea of universal responsibility is the simple fact that every being wants happiness and does not want suffering. Thus, only a right understanding can take the world in the right path, the path of world peace.

Today, governments worldwide have not used much of democratic means to maintain peace, rather bound to display their military character and power to

–*Divya Prakash Srivastava*  
(1st Year, ECE)

# आखिर कैसी आज़ादी का मना रहे है हम जश्न?

सड़सठ साल पहले हम हुए स्वतंत्र  
और हमारे देश ने अपनाया लोकतंत्र  
परन्तु इसअंधेरी रात में पूछती हूँ खुद से ये प्रश्न  
आखिर कैसी आज़ादी का मना रहे है हम जश्न

बीत गए अनेको साल  
कर रही थी उस दनि का इंतज़ार  
जब नया सवेरा एक आशा लेकर आएगा  
उजाले से अपने वो देश में होने वाले अपराध मटि जाएगा

ऐसा क्या प्राप्त कयिा हमने आज़ादी के बाद  
गरीबीए हसिए भ्रष्टाचार और आतंकवाद  
कुछ लोग जी रहे है मथिया डम्बर में  
अधिकतर हाथ फैलाये बैठे है तपते अम्बर में

कसि काम की है ऐसी सरकार  
आज भी लड़ते है लोग पाने के लिए अपने अधिकार  
बाल मजदूरीए कसिान हत्या बन गए मामूली बात  
यही देख और सुन बीत गए दनि और रात

उठो मेरे युवा देश वासयिों  
सुनो भारत माता की पुकार  
देश के लिए कुछ करो  
छोड़ के अपना अहंकार  
पूछो तुम भी अपने आप से यही प्रश्न  
आखिर कैसी आज़ादी का मना रहे है हम जश्न  
आखिर कैसी आज़ादी का मना रहे है हम जश्न

-Avni Malhotra  
1st year, CSE



Soufiane Senhadji © 2010

Nuclear weapons are called weapons of mass destruction for a reason. Any country that has a nuclear weapon in its arsenal is capable of destroying a population of 200,000 instantaneously, leave alone its effects on the people that would haunt them for the century or so.

Their first use of such a technology for destruction for seen by the world during the end of World War 2 when the USA dropped the bomb on Hiroshima and then 3 days later, another one was dropped on Nagasaki. The world had just heard of such things before that day.

Since that day, nearly 2000 tests have been taken by the various nations to add these weapons in their armory.

The world slowly but surely began to recognize that how much havoc these weapons can cause and their potential to end humanity, and this is where the Non proliferation Treaty comes into picture.

Rewind to August 1945 when the USA dropped nuclear bombs ironically named "Little Boy" and "Fat Man". Those two "persons" changed the entire course of World War. That is when the world really came to know what this technology can do that they had only heard about before the incident.

And that is when the countries set forth to understand that they need a treaty or an agreement to control the usage of such weapons if humanity has to be held back from extinction.

And this is where the Non-Proliferation Treaty (NPT) comes into picture.

## What exactly is the NPT?

The treaty aims to prevent the spread of nuclear weapon technology and achieve complete disarmament. It encourages the utilization of nuclear energy for peaceful uses.

By the early 1960's the procurement and development of nuclear weapons had become easy not only to the governments but also for any private entity. The people were starting to be more concerned about the security, in case of any accident, unauthorized use or a nuclear conflict.

By that time, both USA and the Soviet Union had become nuclear powers, and the cold war deterrent relationship was also very fragile. It was in 1968, that an Irish minister Frank Aiken launched the NPT Treaty, which he had been working on for the last 10 years. The treaty was opened for signatures on 1968 and was enforced in the year 1970. As of today, a total of 191 countries have signed the NPT, with the exceptions being India, Pakistan, Israel, South Sudan and North Korea (which withdrew in 2003).

Now enough about the history, let's delve a little deeper into what exactly is this treaty about.

The NPT consists of a preamble with 11 articles, although it is sometimes interpreted as a system consisting of 3 so called "pillars".

### **Pillar 1: Non Proliferation**

This pillar basically prevents the nuclear weapon states members from giving the technology to any other country or to manufacture it themselves. It also makes sure the members don't divert the nuclear fuel for energy to make something more destruction causing.

### **Pillar 2: Disarmament**

This pillar encourages the member nations to go for nuclear as well as complete disarmament and stop production of nuclear weapons.

### **Pillar 3: Peaceful use of nuclear energy**

This pillar promotes the use of nuclear fuel only for peaceful purposes and allows transfer of nuclear technology to countries only if they can prove that they will be using it for energy generation purposes only.

### **India's Stand on NPT**

As for India's stand, it has time and again stated that it will not sign this treaty if it not modified. Why does it say so?

According to the treaty, if a country has tested the nuclear technology for destruction before 1967, it are in luck because it will get to keep the weapons but should not proliferate it. On the other hand, if a country has tested it after that year, it will have to destroy its nuclear arsenal.

India has since long wanted answers to why this unclarified discrimination is being done, without getting any concrete answers.

But we are not the only ones. Israel, Pakistan, Iran and North Korea are also with us in this case because they too have nuclear weapons.

Another reason that India is not wanting to give up its arsenal is that since China gets to keep the nuclear weapons and it's "supposedly" violating the treaty by giving the technology to Pakistan, that two of our neighbours have this technology. Thus, in case any unwanted circumstances happen, we will have an option open that can make any hostile nation go weak in the knees.

But it would be completely wrong to assume that India is against the aim of the treaty. India has a policy of "no-use-against-a-non-nuclear-state" and "no-first-use" which was later reiterated.

### **Is this treaty any good?**

Coming to why we need such a treaty. The first nuclear weapons were made somewhere around 1940. From then till now, apart that one incident, nuclear technology has never been used for destruction. But don't let it enter your mind that this was due to very good management or anything because it was just a coincidence or good luck if you will. And this luck will not continue forever. There are real threats that are starting us in the face right now and if we don't control the nuclear weapon use, we might end up using it against the threats which will eliminate it but will also turn a large part of the world barren. Thus, prevention of this technology is not a choice but a necessity.

Almost every day we see that some country has strained its relations with another country over a particular issue. We need these treaties to make sure that these issues can be resolved with words and not bombs.

Another problem that has recently come to the fore is the advent of anti-social extremist groups such as Boko harem and Al-Qaida. Their aim primarily is to cause destruction to the groups they loathe. And what better way than to seize the nuclear technology and use it to magnify the results that they want?

Although the probability of them getting their hands on such a highly safeguarded technology is little, underestimating their powers is not right.

Another reason we need such a treaty is that the energy requirements will only increase in the coming years. And since the fossil fuels are fast depleting (Duh!), the

countries will depend more on non-fossil fuels. The nuclear energy production will increase. And who guarantees us that the fuel that will be given to the countries will not be used to make weapons?

If we are to seriously work in the direction of complete disarmament, we need treaties like these that bind nations to word toward a safer world, to work towards a world wherein our future generation can live like we do, without any boundaries and constraints.

If we are to make this dream of ours come true, we need to be determined enough and not just the leaders and the politicians but even the ordinary citizens, you and me.

**Arjun Dua**  
**3rd year, MEC**

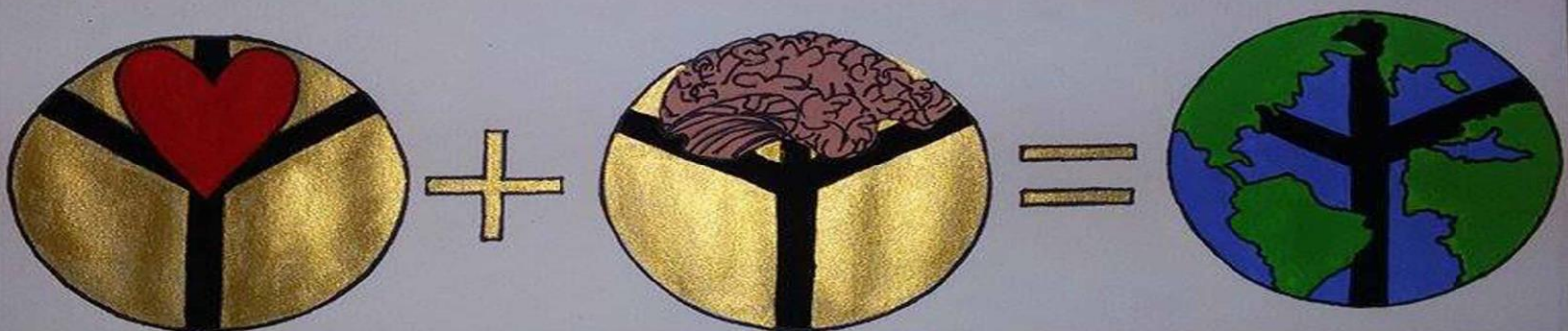

**Avini Malhotra**  
**1st year, CSE**

## C R I S I S

For the last few days, the issue of Article 370 of the Indian Constitution has been attracting the attention of the people who keep track of news through print and electronic media. It is not for the first time that Article 370 has come to limelight after political parties and leaders raked it up. It comes into focus after intervals of few months or few years. While country's one of the largest political party, the Bharatiya Janata Party, has been demanding its abrogation on the ground that the state has got no benefit from it and on the contrary has fostered anti-national sentiment in the valley and sooner it goes better it would be for the state, its people and the country. On the other hand a regional political party, the National Conference, has been advocating its continuation on the ground that it is the bridge between this state and the Indian Union. Similarly, another regional political party, the People's Democratic Party, too sticks its nose for the sake of crass political compulsions and opposes the demand of its abrogation and thus taking the line of National Conference.

While political ball on this issue continues to enter different courts and debate through media goes on among the intelligentsia afresh under the present political climate in the state and in the backdrop of certain developments in the past in terms of state-centre relations, the million dollar question which makes rounds in minds of a common citizen of the state is as to what he or she has gained from it? Has any one from his or her family been benefitted from it? If, yes, what kind of benefit and in what shape it has been? Similarly, other question which comes into one's mind is that if it has harmed a common citizen, why it should continue? Why it should not be

abrogated?

While NC has been advocating Article 370 on the basis that it is a bridge between the state and rest of the country, BJP has been time and again, seeking from its votaries to give out one objective benefit that it entails for the common man, state or the nation. It is a universal phenomenon that any issue which invites criticism from some pockets and support from others, should be discussed. It should have a healthy open debate. Let people come on a platform, express their views on the subject, count pros and cons and then arrive at a final decision taking into account welfare of the state and its people, instead of just issuing statements designed at misleading the people on false outcomes or consequences. What is Constitution? Why a nation needs a Constitution? What should a Constitution have? Should it be just a booklet of few hundred pages with compilation of numerous Articles and Sections, even if they do not give any benefit to the people? Why is it not mandatory that any Article or Section, which becomes hot cake of public discussion should be reviewed and if needed be abrogated or removed.

These are few small yet fundamental questions that need appropriate and rational answers from the political circles that are taking extreme positions over the issue. One of the most authentic logic put while opposing Article 370 is that it bars the non subjects/ people from outside the state to buy immovable as well as movable property here, set any industry or manufacturing unit, while no other state bars any state subject of J&K to invest there, acquire land or set business establishment.

It is true that every educated individual cannot be given government job but the government can work on alternate means to ensure that more and more job avenues are made available to the people. The alternate, therefore, is the

**ARTICLE 370**  
WHAT IS IT?

ing the people on false outcomes or consequences.

What is Constitution? Why a nation needs a Constitution? What should a Constitution have? Should it be just a booklet of few hundred pages with compilation of numerous Articles and Sections, even if they do not give any benefit to the people? Why is it not mandatory that any Article or Section, which becomes hot cake of public discussion should be reviewed and if needed be abrogated or removed. These are few small yet fundamental questions that need appropriate and rational answers from the political circles that are taking extreme positions over the issue.

One of the most authentic logic put while opposing Article 370 is that it bars the non subjects/ people from outside the state to buy immovable as well as movable property here, set any industry or manufacturing unit, while no other state bars any state subject of J&K to invest there, acquire land or set business establishment. It is true that every educated individual cannot be given government job but the government can work on alternate means to ensure that more and more job avenues are made available to the people. The alternate, therefore, is the private sector. Today private sector has achieved new heights in many states. But how the same private sector can grow here in J&K when there is obstacle of Article 370 in attracting the flow of investment from big business houses which are running mega projects and giving employment to thousands of educated youth according to their academic, professional, skilled and non skilled capabilities. Lack of job avenues to the educated unemployed youth of state is forcing them to move out to other states for finding suitable source of

migration of youth continues, it will convert the state into a land of old and aged people in next 15-20 years, which is indeed a very serious matter and need to be taken note of by the government.

It is also said that unemployment in J&K has promoted militancy. A poor youth after completing education with limited resources, after sitting idle for long, gets easily lured by the people who push them into anti-national activities by giving few thousands of rupees. It is therefore high time for the parties which are adamant over what BJP leadership has been advocating on genuine grounds to look at the issue from the prism of common masses and their interests and not just their own political interests and pandering to the emotions of a small segment of valley's population. Moreover, it is time for entire state, people in all the three regions as a matter of their right to look afresh into pros and cons of this Article and assess things themselves instead of getting entrapped every time into the jargon of Kashmir politicians.

Even otherwise, if a common man from the society, who is neither a political figure nor an intellectual or academician, is told that Jammu & Kashmir is an integral part of India like any other state but Article 370 provides for separate flag and separate Constitution, his reaction would be –why it was not abrogated during all these years after its incorporation for a temporary period?

By - Siddharth Sharma  
2nd year, ECE

# TIBET

Tibet is a region in north-east of the Himalayas. It is the highest region on Earth, with an average elevation of 4,900 mts. It is also called the "Water Tower" of Asia as it originates major rivers, including the Mekong, Yangtze and Salween.

Tibet has unique and rich variety of performing and creative arts. Religion is extremely important to the Tibetans and has a strong influence in over all aspects of their lives. Primary influence on the art, music, and festivals of the region is Tibetan Buddhism. Tibetan Buddhism has four main traditions: Gelug(pa), Kagyu(pa), Nyingma(pa), Sakya(pa).

But the glorious and rich culture of Tibet was invaded by the Chinese Liberation Army in 1950 without an accepted legal basis for claiming sovereignty over the country. There is a bulk of evidence to show that Tibet was an independent country. It had its own currency, postal system, its own government and diplomatic contact with other countries. Following the invasion China signed a "17 point agreement" with HH the Dalai Lama agreeing to refrain from interfering with Tibet's government and society. In 1959 there was an uprising by the Tibetan people which was crushed by the Chinese. An estimated 4,30,000 people were killed and 1,00,000 Tibetans fled to India to exile with the Dalai

Lama. Several self-immolations also took place.

Human rights violations in Tibet cover civil, political, economic and social issues. Since then 6,000 monasteries have been destroyed and Tibet's unique culture is under threat. There is no freedom of speech and the "Tibetan Autonomous Region" has the most surveillance cameras per head of population in the world. Possessing a photograph of the Dalai Lama is illegal. Arbitrary arrest and torture of prisoners-of-conscience dominate international human rights concerns and even non-violent protests are suppressed with imprisonment. Tibetans live in exile as refugees with limited legal rights. Standard of Health and well-being is degraded.

Not only this but China is also relocating thousands of Han Chinese settlers to the Tibetan Plateau. Although a minority in the population these settlers control the economies of major cities like Lhasa. There is a real risk that in the coming decades Tibetans will become a minority in their own country as has happened in Inner Mongolia.

Since fleeing Tibet in 1959, HH the Dalai Lama has established a democratic government based in India. The Tibetan Government-in-Exile (TGiE) preserves Tibetan culture and identity that is rapidly being destroyed in Chinese occupied Tibet.



TGiE demands rehabilitating Tibetan refugees and restoring freedom and happiness in Tibet. It has a policy of dialogue with China to reach genuine Autonomy. Many governments around the world have acknowledged the need for a fair resolution in Tibet but have so far failed to recognise the TGiE as legitimate. China's policy of occupation and oppression has resulted in no

more or less than the destruction of Tibet's national independence, culture and religion, environment and the universal human rights of its people. Time and time again, the infliction of this destruction sees China break international laws with impunity. In my view the first priority must be resettlement and the continuity of Tibetan cultural traditions.

*Avni Malhotra  
1st year, (CSE)*

## *My Heart On Bid*

**Mind full of thoughts  
Pen started running down the page  
Words coming out are tragic al-  
though Aptly describes a life in  
cage...**

**Your actions you thought it right  
But please feel it from my side  
It might tremble your morals then  
And wash your hatred all aside...**

**You never knew your importance to  
me Tried to be apart and did  
Left me helpless and moved on  
My heart's on auction waiting for  
your bid...**

**The time I was waiting for has ar-  
rived U're face in my mind has  
blurred,  
I thank god for this great favour  
Made u fly from my mind like a bird  
.....**

**..... By :- Apurv Vats  
2nd year ,ECE**



# Baltimore Riots : America Burning

Baltimore, a city commonly known as the "city of neighborhoods" is the largest city in Maryland State in the United States of America whose residents include famous personalities like Edgar Allan Poe and Frederick Douglass.

Baltimore riots were a set of peaceful protests gone wrong. The protests gradually developed violent elements where around 98 policemen were injured and 2 people were shot. The violence included protests, rioting, arson and looting leading to deployment of Maryland Army National Guard troops and an emergency being declared in the city limits of Baltimore.

The entire problem started when Freddie Gray, a 25-year-old African American died in police custody after a week under police arrest on April 19, 2015. He reportedly was in good physical condition when he was arrested exactly a week before his death. Freddie Gray went into a coma as a result of injuries to his neck and spine while being transported in a police vehicle. The death gave rise to peaceful protests, which towards the end, developed violent elements. A set of people became violent and wreaked havoc in the city by damaging at least 5 police vehicles and pelting stones at the police. Following the funeral procession on 27th April, 2015, violent activities took place starting from pelting of stones to looting

and arson over the next two days leading to the arrest of 254 people and an estimated damage to 200 businesses and torching of 144 cars.

Apart from the fact that property has been damaged and people have been injured, what comes to light as a consequence of this violence are various reports that point towards the police brutality in the city over the years. A report from the Huffington Post states that in 2005, Baltimore PD arrested 76,497 people without warrants out of which, the prosecutors declined to charge 25,293 people. The prosecutors could not charge 7,510 people for loitering, impeding or obstructing pedestrian traffic. Again, the prosecutors failed to charge 1,832 people charged for trespassing or 1,650 arrested for disorderly conduct/disturbing the peace/failure to obey. In 2006, the American Civil Liberties Union filed a class action complaint alleging a pattern of false arrests. Of more than 76,000 people arrested the previous year, prosecutors declined to charge 25,000 with any crime - meaning roughly 30 percent of the arrests were basically bogus. In a 2010 settlement, the city agreed to reform its police practices, though last year the Baltimore Sun reported on a persisting pattern of police brutality.

It is true that these were not protests. Rioting, looting and arson are not forms of protest but a sign of hooliganism in the area. Even rioters have a reason for riot-

ing, and unless officials try to understand it, no number of National Guard troops will effectively stop them. But do we ever think of reasons as to why these protests turned violent? Was it just the police brutality over the years?

One perspective is that 'police brutality was a precipitating cause of the violence, but it was the long-term experience of the indignities of the ghetto that gave shape to the riots.'

Ironically, there are 2 views emerging from these riots:-

1. The Humanitarian View
2. The Political View

### **The Humanitarian View-**

Now, there is a certain section of the people i.e. the African American people, that states that the state including the police and the society have been increasingly unjust to them. The criticism of the police is as a symbol of an entire web of failed social policies on education, employment, health and housing. Their claim, supported by statistics is that they do not have proper representation jobs. Precisely for Baltimore, the median household income at \$33,000 is less than half of their White counterparts. The unemployment rate for Blacks is 37% whereas for their White counterparts, is

has lead the residents of Baltimore to such a state. Racism, as a factor cannot be ruled out but it cannot be counted as the only factor. The government has failed the people time and again. The most recent incident being these protests. There were peaceful protests for a week after Freddie Gray's death, the mayor of Baltimore did not react to those protests and did not come out even once. Moreover, the city council stopped responding to people's requests. It was not until the violence started that the authorities started responding and the Mayor came out to talk. Violence conquered what could not be conquered by peace. But this in no way states that violence is justified but in this case, violence changed a lot of things.

On strictly humanitarian grounds, when a minority irrespective of the caste, colour or religion, is downtrodden, the role of the government must be to lift them up. Here, the minority had been trampled upon until they had their back against the wall. And then they started fighting back for all the frustration that they had been subjected to. It's been going for a couple of years. It happened in Ferguson, Oakland and now Baltimore among other places and will continue in the coming years if the government fails to address these basic problems and starts making effective policies to

way around the world rather than on internal issues. There has been funding for internal issues as well but nothing substantial as compared to that of foreign operations.

As John Angelos puts it – “My greater source of personal concern, outrage and sympathy beyond this particular case is focused neither upon one night's property damage nor upon the acts. It is focused rather upon the past four-decade period during which an American political elite have shipped middle-class and working-class jobs away from Baltimore and cities and towns around the U.S. to Third World dictatorships like China and others, plunged tens of millions of good, hard-working Americans into economic devastation, and then followed that action around the nation by diminishing every American's civil rights protections in order to control an unfairly impoverished population living under an ever-declining standard of living and suffering at the butt end of an ever-more militarized and aggressive surveillance state.”

Another important thing pointed out by political analysts is that Baltimore has seen only 2 Republicans in the Mayor's office since 1920 and none since 1960. The city is overwhelmingly Democratic, effectively a single-party political monopoly from its schools to its police department. American cities are by and large Democratic-party monopolies, monopolies generally dominated by the so-called progressive wing of the party. Now this seems to have made a big impact. Until and unless there is a change of ideology in office, a city or a state cannot progress. As soon as a monopoly is created, progress starts lagging. That's exactly what's happening in American cities now and the result of which is being borne by the minorities.

Another very interesting view is that involvement of business magnates like George Soros is also a big contributor to these riots. George Soros is often described as – “A liberal billionaire who has built a business empire that dominates across the ocean in Europe while forging a political machine powered by nonprofit foundations that impacts American politics and policy.” He is famous in Europe as a man that has made his fortune bankrupting nations and impoverishing their peoples for his political and business interests. It has been reported by way of tax filings that he'd spent \$33 million in the past year through his NGO to support protestors in Ferguson which was similar to what happened in Baltimore.

Irrespective of the number of reasons given for the civil unrest in the country, it all falls into the lap of the government. As long as there is no political will, minority-based problems cannot be solved. The United States needs to focus more on these issues rather than on what's happening half way around the world. Otherwise, this problem may force America to 'fall.'

**Nabeel Faruqui**  
2nd year, MEC

# AIIB: The Dragon On The Prowl

The Dragon in the East has snarled yet again. The decades long slumber has finally broken and its now out of its lair to finally hunt for its prey and subsequently to assert its might on the World Stage. The Deng Xiaoping era strategy of “Hide your light, Bide your time”, has been abandoned. Under General Secretary Xi Jinping, Peoples Republic of China has gone through a complete metamorphosis and has come out as much more asserting nation that demands its rightful position in the world arena.

China and other major developing economies have long expressed their dissatisfaction with US and European dominated international institutions created at the end of WWII. China's efforts to increase its contributions and hence voting power in the IMF, for instance, have been stalled for years in the US Congress. The reservation of the top job in each of the World Bank and the IMF for citizens of the US and EU, respectively, is offensive. The deal between the two that has stuck for over sixty years smacks of a global Tammany Hall racket.

In his latest book Henry Kissinger anticipated China's initiative to create the first new international organization of the 21st century. He didn't foresee the Asian Infrastructure Investment Bank (AIIB) as such, but argued that as China continued to increase its global economic weight, it would inevitably seek its security, in part, by building international organizations in which it sat at the center. And that this would rightly or wrongly be seen as a challenge to the post-World War II US-centric international architecture.

That China would build its own international bodies, and will continue to do so, shouldn't be a surprise. In response mainly to increasing US presence in Central Asia—especially after the American's gained permission from Uzbekistan to base air force assets there for the Afghanistan campaign—China created the Shanghai Cooperation Organization (SCO). Since its inception in 2007, it has expanded its membership and increased its activities, including regular heads of state meetings and joint military exercises.

China also initiated the BRICS Bank in 2012. The BRICS (Brazil, Russia, India, and China) had little in common at the time, other than an easily remembered label. China was most unlike its partners. Apart from its authoritarian political system, China has nearly \$US4 trillion in foreign reserves and only a tiny amount of foreign currency denominated debt. China doesn't have to fear capital flight in the event of an end to US quantitative easing when interest rates would start to rise. It's likely that we may not hear much more of the BRICS Bank, especially now that the AIIB has been established.

In contrast the AIIB plays to all of China's strengths. Over the past two decades, Chinese construction companies have demonstrated remarkable capacity to build infrastructure, be it power stations, expressways, ports or high-speed trains. To some extent, China's infrastructure is becoming built out and Beijing is looking increasingly to exporting this capacity. On straight commercial grounds, China's construction companies would be well positioned to grab the lion's share of the bank's funded business. But as China has founded the Bank and contributed the bulk of its capital, this is guaranteed.

Early proposals suggest that the AIIB's initial capitalization might be in the order of US\$100 billion, with China contributing about half. More recently, this seems to have been wound back to around \$50 billion, with countries only required to contribute a small portion of their overall commitments, including China. China will still be the biggest contributor, but its approach is likely to be more measured than originally suggested, and as such will still carry the most weight in the new organization.

The Bank's founding coincides with an important change in China's foreign policy under Xi Jinping. Since the late 1970s, China's foreign policy has been governed by Deng Xiaoping's maxim of "hide your light, bide your time." Foreign policy had one principal objective beyond China's security and that was to support China's economic development. Although China had begun to take a leadership role in international institution building and to adopt a more assertive policy under Xi's predecessor, Hu Jintao, Xi's incumbency marks a break with Deng's approach and the adoption of a more muscular foreign policy. This can be seen in the South China Sea, in the Senkaku/Diaoyu Islands dispute with Japan, and in a number of initiatives from institution building to agreements with the US on greenhouse gas emissions controls.

The AIIB also fits well with Xi Jinping's far-reaching, ambitious New Silk Road initiative. As is standard in China, the articulation of

policy often follows what has already been put in practice. In this case, Beijing has been building pipelines across Central Asia and Myanmar, train lines from Chongqing to Duisburg in Germany, and road links into Pakistan and a new port near Karachi for years. Throughout its entire history, China has been largely self-sufficient in natural resources and energy. But since its economy began to grow rapidly in the mid-1990s, it has found itself increasingly dependent on international markets for the resources and energy it needs to sustain growth.

And nearly all of these imports must go through the Straits of Malacca. China's at least 20 to 30 years away from being capable of challenging the US militarily in the Straits. For strategic planners in Beijing this is a major vulnerability. The New Silk Road is therefore intended to give Beijing strategic options, and the AIIB is a means to pay for it.

China could have tried to achieve this solely through bilateral investments and loans. Instead, it has decided to bind itself in part in the rules of an international organization. This is already contentious in China as some are arguing that it shouldn't constrain itself in this way, but should instead act unilaterally. Regardless, the leadership has decided that a multilateral institution will give greater legitimacy to its strategic objectives.

Inevitably the Asia-Pacific is being reshaped by China's emergence as the dominant economic power.

**Siddharth Sharma**  
**Second year, CSE**

# CROSSWORD

## Across:

1. A movement that forbids Western Education (9)
2. Ron who has legally changed his name to 'World Metta Peace plays' for which Basketball team? (6)
3. How many leaves does the International Peace Day logo has? (4)
4. Unconditional love for all beings (5)
5. Mother Teresa lived in which city of India? (7)

## Below:

1. How many incarnations of Dalai Lama have been recognized till now? (8)
2. Members of unification church of the United States are called? (6)
3. Indian Nobel Peace Prize winner in 2014 is \_\_\_\_\_ Satyarthi. (7)
4. UNESCO headquarters are situated in? (5)
5. An organization that provides food and health care to children. (6)

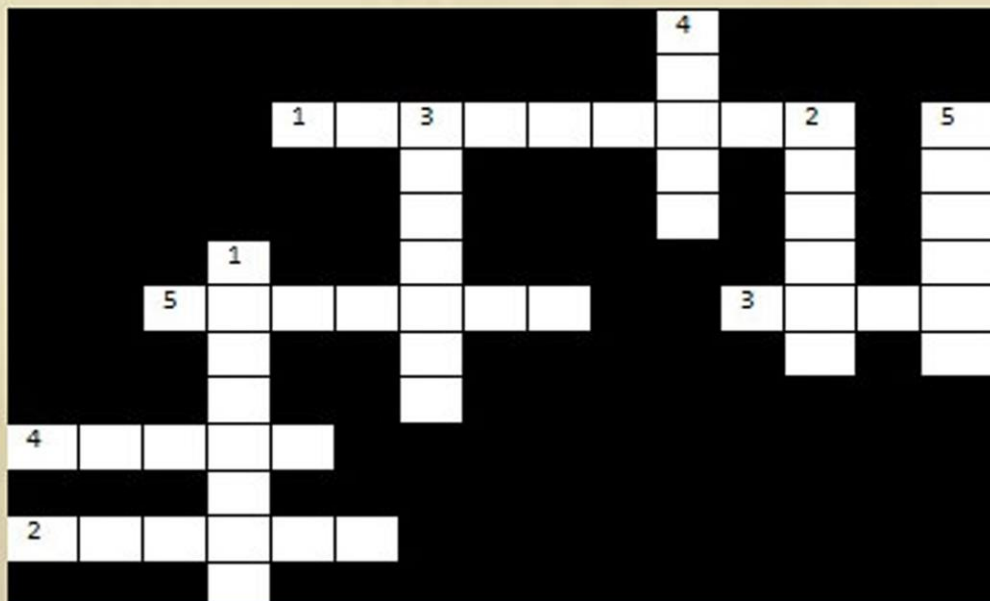

ANSWERS:  
**Across:**  
 1. Bokoharam  
 2. Lakers  
 3. Five  
 4. Metta  
 5. Kolkata  
**Below:**  
 1. Fourteen  
 2. Moonie  
 3. Kailash  
 4. Paris  
 5. UNICEF



# TEAM BLITZ

## A Journey through falling night to a rising sun.

It was a usual day for every Juetian except for those 19 who had different plans for this year. A meeting was held and it was decided to fabricate a go kart this time. We decided a plan to approach for this competition Initially we divided the work amongst every member of the team and.

In no time the preparation started for virtual round and sooner the date came, our elite teammates went for it and the other teammates were still busy in mastering their field of work. We were confident that we'll clear the virtual round. And it so happened accordingly.

That was the moment everyone one was waiting for, everyone was too excited to proceed but only a handful within us had any experience in fabrication work.

William Arthur Ward has rightly said "adversity causes some men to break; others to break records" as we were of the second genre, that we realized later. We started our journey to fabricate go kart with prime dictum of

doing well. But with no sponsorship it was a stupendous task to steady the ship but we sailed it past pretty comprehensively. With tenacity, perseverance we started fabrication work of go kart, we had few failures in between, even we preoccupied at some state of our mind that we could not make it but, we never gave up and finally made a kart which was hitting the road smoothly Event day was approaching too fast and we barely had any time to go for testing, and that was a thing of prime importance, as we know sacrifices have to be made to achieve anything, so our teammates sacrificed their lecture hour and spent more time with the GO KART. We all know leaving lecture was going to cost us immensely but we didn't had any option.

Just a day before leaving for event worst thing happened clutch was not working properly and tie rod broke but due to the lights of knowledge which we had gained during that span of

time, we were able to fix that nightmare in time.

Finally we sailed for the event but we were so low esteemed that we even doubt that we could clear technical inspection. But everyone was staggered by our innovative ideas like use of centrifugal clutch and all other things that gave us glimpse of confidence.

And eventually we cleared technical inspection, did great job in Brake test on the second day.

Now 24 teams were left at the end of 2nd day and teams were preparing for the final run in which our team rocked and we were in the top 10 at the end of the day. Our GO KART hit the newspapers with highest views

And this was journey of our collective team efforts, our persistence, our never lose hope thing and the realization of our college motto

**Hrishi Jain,  
2nd year, MEC**

**“ NO DREAM TOO BIG ”**



# Mars Orbiter Mission India's Gateway to the Unknown

50

Nabeel Faruqui  
2nd year, MEC



At 07:41:46 (IST) on 24th September, 2014, India became the first country to insert its satellite into the Martian Orbit in its first attempt and the first Asian country to successfully execute an inter-planetary Mission.

The Mars Orbiter Mission (MOM) was the brainchild of Dr. K. Radhakrishnan, the Chairman of the prestigious Indian Space Research Organization (ISRO). The idea of an inter-planetary mission was conceived in 2010 when a feasibility test was conducted to evaluate ISRO's potential to achieve the near-impossible and an approval achieved. Riding high on the success of the Chandrayaan Mission in 2008, ISRO capitalized on this opportunity to introduce India as the next big player in the space research circuit.

As stated by ISRO, the main objective of the first Indian mission to Mars is to develop the technologies required for design, planning, management and operations of an interplanetary mission. In simple terms, MOM would analyze Mars from some distance evaluating the presence of deuterium, hydrogen and methane present in the upper atmosphere of Mars. Moreover, it would measure the temperature and emissivity of the Martian surface, allowing for the mapping of surface composition and mineralogy of Mars.

The entire project cost approximately ₹454 crores to the Indian Exchequer.

Now considering the bigger picture, our Honourable Prime Minister Narendra Modi was all praises for the success of the mission. In the heat of the moment, he went on to say that MOM was better than the MAVEN (mission of the NASA taking place simultaneously) as it cost much less. It even cost less than the recent Hollywood Sci-fi flick Gravity. Now the great irony lies in the fact that here, we've overestimated our mission. The point being this that MAVEN is a rover project and not just an orbiter mission, which means that the American mission would actually land on the surface of the Mars to evaluate various factors there.

There is no denying the fact that MOM is one of the greatest achievements for India since 1947 but we've wandered away from reality a bit. The point being this that the USA already had a rover planted on Mars in 1976 that is to say that, technically, we're at least 40 years late to the party. So there's no comparison there. The fact of the matter being this that when we compete, we might as well compete with the big cats of the game rather than celebrating our victory over smaller nations. We know, since 1976, that there was water on Mars once all thanks to the Viking Program of NASA. We still need a lot of time to catch up with the likes of the USA, Russia and the Europeans.

# Say - Yes

Negativities aside, the Mars Orbiter Mission is a great success for India making way for a lot of opportunities to be explored by this country. Mars mission is a major step forward in our space program and a turning point for us, as India will foray into the vast inter-planetary space for the first time



*K. Radhakrishnan - The man behind MOM.*

This is one giant leap for our country to capitalize upon and contribute greatly towards the research and study of the unknown, of what lies beyond, of what our minds cannot possibly perceive at this point in time .



Launch of the satellite

Maybe too high,too much shy,  
didn't wanted to talk to me,why?  
dry was my mouth when i first saw you,  
felt enchanted heart rate high  
wanted to see you again,met you on face-  
book,  
took the first step & messaged you,  
heartlessly no reply,did'nt understood, why?

i know i'm not the most good looking man,  
but i don't see you the same as other men,  
i've loved you since the day i saw you,  
i 've never been the same since then,  
but i want to know what's wrong,  
i can write you a jingle if you like or a song,  
maybe i didn't tried harder to get you,  
i thought you want me to cry,  
sorry baby i can't,

i won't actually,  
there's no such need,  
i can't bleed for you & can't promise to die,  
cause maybe still there is a silver line,  
very thin that always shine,  
if i would've given away everything,  
then how could i spend with you my whole  
life,  
like a knife,cutting everything in two,  
if you ask me I LOVE YOU then i'd say YES I DO,  
there are too many questions and no answers,  
a lot of why why and why  
don't worry,after reading this you could say  
no,  
we'll never meet,but till then atleast i can try...

Sandeep Thakur  
3rd Year, MEC

## BY- AMITABH BACHCHAN



JRD Tata had a friend who used to say that he misplaces and loses his pen very often. He would use only the cheaper ones so that he need not worry about losing them. He was worried about his carelessness.

JRD suggested him to buy the costliest pen he could afford and see what happens.

He did that and purchased a 22 carat gold Cross pen.

After nearly six months JRD met him and asked him if he continued misplacing his pens.

His friend said that he has become very careful about his costly pen and even he is surprised by the fact that he has changed!

JRD explained to him that the value of the pen made the difference and there was nothing wrong with him as a person!

This is what happens in our life.

We are careful with things which we value the most.

\* If we value our Health, we will be careful about what and how we eat;

\* if we value our Friends, we will treat them with respect;

\* if we value Money, we will be careful while spending;

\* if we value our Time, we will not waste it.

\*if we value Relationship we will not break it.

Carefulness is a basic trait all of us have,

we know when to be careful!

Carelessness only shows what we don't value...

Have a wonderful & careful life...

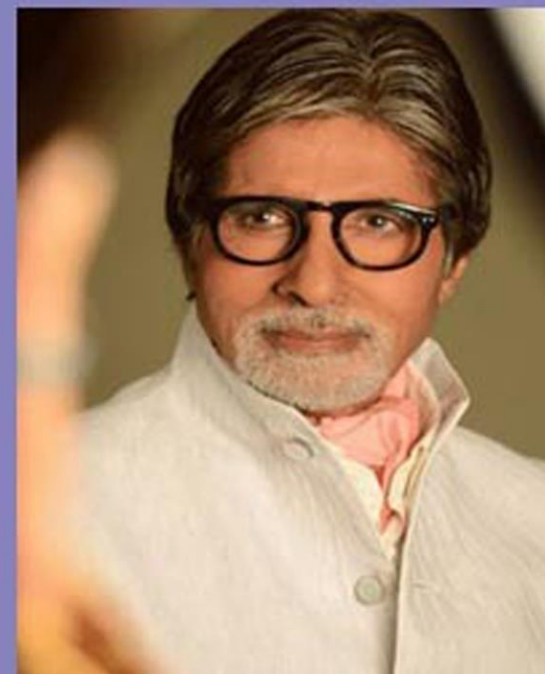



# CHANGE

## Because, its not just the end!!

I will not start with saying that people like you and me should start changing the society, making India a better country to live in. What I will say is that when I look around myself, I see dishonor, lawlessness, deceit, thanklessness in more forms that one could imagine. When I look within, I see a meaningless existence full of materialistic inclinations. I see pain, suffering, hunger and death. I see hate, agenda, motives and power. Because today I realise how utterly foolish and far away from reality it has been, to be talking about positivity, when we live in a society where so-called human beings exhibit animal-like behaviour at will. No, in fact, let me apologise to the animals for making this statement, because even they are known to have traces of compassion and kindness.

But today I would not call any one of them hero because then it would be unfair to the hundreds of thousands who have died before. It would be unfair to the righteous civil servant, to the brave mother, to the brave soldier, to the hardworking government employee - hundreds and thousands who have been oppressed by a system that mauled them, then oblivion - while the remaining billion carried on - because that's what they had always been told to do. What we have come to - I don't know. I will not try to define it - for it is beyond words. Have we turned a blind eye to this? Yes, we

have. Own up. We've been too involved in the latest political news half way across the world. Anyway, the point that I'm making is this, while there are millions of girls in our country who grow up facing harassment of some kind at the hands of rogue men who think this is a way of exercising their power, I'm not likely to find many supporters for my theory, considering it's almost always cases of women that get sexually harassed by men come to the light, but let's face the reality. On hearing about a rape case or any such incident of harassment, although a woman's reaction may be more empathetic considering they can imagine what the victim may have gone through, I can bet on the fact that an equal number of men and women also end up saying things like 'she shouldn't have dressed this way.' 'If a girl would go dancing late night in a club, what else does she expect'. Okay wait ! I know this is quite ridiculous and there is no end to this. There is cancer in our very mindset for several generations, some patients get noticed, some don't. In short I would say, spoken words are just the beginning, change has to start somewhere.

**BY-**  
**ANKITA MISHRA**  
**1st year, CSE**

# Womensera

A woman is the full circle. Within her is the power to create, nurture and transform.

Woman is the companion of man, gifted with equal mental capacities but unfortunately she is often taken for granted in patriarchal society. Women are by no means less competent than men. Women of 21st century have proven their worth by competing with men in all walks of life.

Rabindranath Tagore has rightly said "Women you are blest, you have taken upon yourself the creators work and are his helpers. You open the way to recovery and ever renew the outworn world. Quietly bravely in beauty's form, you carry within you the preserving force of universe and for the faith, the broken, the deformed the gracious touch of the lovely one."

Frailty, tenderness, weak, compassion are few words often used to symbolise a woman, but who can disown the fact that today's women are capable of re-shaping the economic, social and political aspects of a country.

## -Diane Mariechild

One more acknowledge that women are the magnificent creation of God, a multifaceted personality with the power of benevolence, adjustability, integrity and tolerance. She is the embodiment of love and affection. The part played by the women in the society is a measuring rod and true index of its civilization attainment.

The truth, which pertains to the fact that stealthily, she has flourished from a tiny seed to a lush green crowned tree, creating a panorama of talents in several branches of life's sphere. From media and politics to science and arts, eminent women have proved that the synthesis of their invincible quality is the requirement of the fruitful gains of this frail humanity.

The various roles played by the women today have become an epitome of their undaunted and impervious spirit. The world must welcome these pearls of wisdom and jewels brightened with soul's purity.

Tanya Arora  
2nd year, CSE

# HOW INFERNO SWEEPED BILLIONS OF SMILES?

It has been said, 'time heals all wounds.' I do not agree. The wounds remain. In time, the mind, protecting its sanity, covers them with scar tissue and the pain lessens. But it is never gone.

A natural disaster can cause loss of life or property damage, and typically leaves some economic damage in its wake, the severity of which depends on the affected population's resilience, or ability to recover. It also lay bare the best and worst in people, stripping away hubris and artifice.

An adverse event will not rise to the level of a disaster if it occurs in an area without vulnerable population. In a vulnerable area, however, such as San Francisco and Nepal, an earthquake can have disastrous consequences and leave lasting damage, requiring years to repair.

## HAITI-QUAKE

Five year later, scars of the tragedy remain in Port-au-Prince, the earthquake that hit Haiti on 12 Jan 2010 affected almost 3.5 million people, including the entire population of 2.8 million people living in the capital, Port-au-Prince. The Government of Haiti estimated that the earthquake killed 222,570 and injured another 300,572 people. Displacement peaked at close to 2.3 million people, including 302,000 children. At least 188,383 houses were badly damaged and 105,000 were destroyed by the earthquake. Sixty per cent of Government and administrative buildings, 80 per cent of schools in Port-au-Prince and 60 per cent of schools in

the South and West Departments were destroyed or damaged. Total earthquake-related loss is estimated at \$7.8 billion, equivalent to more than 120 per cent of Haiti's 2009 gross domestic product.

The wounds are still there, and everyone says that they're living in worse conditions than before. Thousands of people are still struggling to eke out a living.

A cholera epidemic, blamed on U.N. troops sent to the country to help, followed shortly after the earthquake, delivering another blow to the Caribbean republic that is the poorest country in the Western Hemisphere. The United Nations has denied legal responsibility for the ongoing cholera outbreak that has killed 8,000 Haitians, but all scientific evidence points to poor sanitation at a peacekeeping base.

According to the Humanitarian Action Plan for Haiti 2014 an estimated 172,000 people remained internally displaced in Haiti in 306 camps at the end of 2013, almost four years after the earthquake. Basic services in camps, including WASH and health, had declined faster than the pace of return or relocation of the displaced. 16,377 displaced families living in 52 camps were considered at high risk of forced evictions. Almost 80,000 people lived in 67 camps considered to be at particularly high risk of

flooding, with an additional 30 camps at additional environmental risks.

When we walk around the country's capital Port-au-Prince, you still see half-destroyed buildings around town

And yet the situation on the ground is dire, two years ago, there were still refugee camps in Port-au-Prince's center. Now, they are gone, but the people have been merely displaced. They now live in the city's suburbs – in these prefabricated shacks ,a parallel economy.By mid-2014, an estimated 104,000 people remained internally displaced in 172 camps. Almost 70,000 IDPs were not currently targeted by any return or relocation programs. By Sep, 85,432 people remained internally displaced in 123 camps.

Given the costs of recovery from such a shattering catastrophe, it might seem logical that an impoverished country such as Haiti would still feel the effects a half-decade later, if it weren't for the unprecedented help the Republic received in its aftermath. When we look at the history of humanitarian relief, there's never been a situation when such a small country has been the target of such a massive influx of money and assistance in such a short span of time.

The international community has crushed the country's hopes. NGOs are pulled out, creditors had stopped investing. Haitians find themselves in a social and economic situation that is worse than before the earthquake. And yet, its people subsist. "I feel there's this collective energy that comes from how close all Haitians live with each other. There's this idea of collectivity, which leads to certain neighborhoods taking control of their own fate – cleaning up their streets, opening up their schools, etc. They have been forced to take over

from the government, which is unable to offer these services."

Still, nodoubt that Haitians will bear the crisis, even as it stretches on. It's already a victory to see that the country hasn't exploded, especially when we see what has happened in the last decades — from Jean-Claude Duvalier to Jean-Bertrand Aristide, from the cholera to hurricanes, the country has faced a succession of social, political and environmental crises. The fact that Haitians haven't succumbed to madness shows that they're resilient.

### KATRINA

Hurricane Katrina was one of the deadliest hurricanes ever to hit the United States. An estimated 1,836 people died in the hurricane and the flooding that followed in late August 2005, and millions of others were left homeless along the Gulf Coast and in New Orleans, which experienced the highest death toll.

According to the Officials at the National Oceanic and Atmospheric Administration Katrina was the most destructive storm to strike the United States. It ranks sixth overall in strength of recorded Atlantic hurricanes. It was also a very large storm; at its peak, maximum winds stretched 25 to 30 nautical miles and its extremely wide swath of hurricane force winds extended at least 75 nautical miles to the east from the center.

Katrina initially formed over the Bahamas on Aug. 23, 2005, as a tropical depression. A well-defined band of storm clouds began to wrap around the north side of the storm's circulation center in the early morning hours of Aug. 24. With winds of about 40 mph (65 kph), the storm is named Tropical Storm Katrina.

By the time it made its way to southern Florida on Aug. 25, Katrina was a moderate Category 1 hurricane. While it caused some

killed — during its first landfall, it appeared to be just another hurricane in an active hurricane season. Katrina weakened after passing over Florida and was reclassified as a tropical storm.

But, once over water again, Katrina stalled beneath a very large upper-level anticyclone that dominated the entire Gulf of Mexico, and rapidly gained strength. Katrina re-intensified into a hurricane on Aug. 26, and became a Category Five storm on Aug. 28, with winds blowing at about 175 mph (280 kph). The storm turned north toward the Louisiana coast. The storm weakened to a Category 3 storm before making its second landfall along the Louisiana-Mississippi border on the morning of Aug. 29.

Katrina's front-right quadrant — which held the strongest winds — slammed into Gulfport and Biloxi, Miss., devastating both cities. Several levees in New Orleans collapsed and the city began to flood. Thousands sought refuge in the New Orleans Convention Center and the Superdome, which were overwhelmed. The National Guard was called in to help with evacuations.

Katrina weakened to a Category 1 hurricane after moving inland over southern and central Mississippi. It was downgraded to a tropical storm about six hours later just northwest of Meridian, Miss., but not before causing a tremendous loss of life and property damage across a wide area, extending beyond Louisiana and Mississippi into the Florida panhandle, Georgia, and Alabama.

#### Political storm

Critics blamed an aging and neglected levee system and a slow response following the disaster for the high loss of life and damage. Many residents did not heed initial warnings to evacuate, putting a severe strain on rescue operations.

Ultimately 80 percent of New Orleans and large portions of nearby parishes became flooded, and the floodwaters did not recede for weeks. Coastal areas, such as all Mississippi beachfront towns, sustained some of the worst devastation. Total property damage from Katrina was estimated at \$81 billion, which was nearly triple the damage inflicted by Hurricane Andrew in 1992.

The rescue and recovery efforts following Katrina became highly politicized, with federal, state and local officials pointing fingers at one another. After initially receiving praise from then-president George W. Bush, the director of the Federal Emergency Management Agency (FEMA), Michael D. Brown, was forced to resign, as was New Orleans Police Department Superintendent Eddie Compass.

In particular, Mayor Ray Nagin came under severe scrutiny for his administration's response in the aftermath of the disaster, but he vowed to rebuild. He was re-elected in 2006 but his second term saw a high rate of crime in the city and he faced many roadblocks from critics in his efforts to rebuild.

The region is still recovering, and government officials have sought to learn from the tragedy and implement better communications and evacuation policies. While many of the tourist areas such as the French Quarter have recovered, there are still neighborhoods just a short ride from the city where the effects of Katrina can still be seen.

Five years later, scars from the storm are still visible on the Gulf Coast's delicate ecosystems, including its barrier islands. Katrina's ferocious winds and waves washed away these islands, killed hundreds of millions of trees and transformed marshlands into giant lakes.

The destruction took place in ecosystems

that were already slipping away because of unsustainable development; Katrina simply added fuel to the fire. Today these fragile features are only beginning to heal. But they will never be the same, say scientists. And they will be sustainable only if they can be reconnected to their lifeblood — the Mississippi River.

### JAPAN-TSUNAMI

The tragedy in Japan — a 9.0-magnitude earthquake followed by a killer tsunami and compounded by a nuclear accident at a tremor - and-tidal-wave-damaged power plant — brought into relief the remarkable resilience of the Japanese people. Defining a national psyche can be a tricky undertaking. But the dignified stoicism with which the Japanese have faced this tragedy is extraordinary to see.

Japan's resilience, however, is not solely to be explained in terms of some innate psychological trait that its people possess. It is also manifested in the nation's preparedness. As high as the official death toll climbed, there was little doubt that the complex tsunami and earthquake early-warning systems that Japan has in place saved tens of thousands of lives. Now as Japan struggles to overcome one of the worst natural disasters in its history — though the earthquake on March 11 was the most severe in modern times, far fewer died than in the Great Kanto Earthquake of 1923 — it will need even more reserves of fortitude to remake a nation that is all too familiar with losing everything and starting anew.

Marooned on the edge of a continent and perched on one of the most seismically active spots on earth, Japan, for all its modern comforts and luxuries, is a country that lives on the brink of disaster. Even its language is a testament to how this sense of precariousness has shaped the national consciousness. I say this as

someone who is half Japanese and should know how to articulate a nation's mind-set. But even I find it hard to define *gaman*, a unique mix of endurance and self-abnegation that practically all people I spoke to in the disaster zone used to describe their situations. Or what about *shoganai*, which is often translated too simply as "There's nothing you can do"?

That's not quite right. The fatalism implied in the phrase denotes not just a helplessness at life's vagaries but also a calm determination to overcome what cannot be controlled. Even those who never lived through Japan's last days of privation during World War II know what is required of them as Japanese citizens. "We, the young generation, will unite and work hard to get over this tragedy". "Youth says now its their time to rebuild Japan."

This earthquake and tsunami may turn out to be the costliest natural disaster in history, outpacing even Hurricane Katrina in 2005. The gravity of the situation was underscored when Emperor Akihito appeared on March 16 for his first-ever televised address to say he was "praying for the safety of as many people as possible," a sentiment repeated by a grim-faced Prime Minister Naoto Kan in daily public appearances. Nevertheless, despite the cost and loss of life, Japan's ultra-sophisticated earthquake-and-tsunami-alert system increased the odds for everyone. The earthquake unleashed its fury. Then because of radio broadcasts, text messages, sirens, firemen's door-to-door calls and just plain instinct honed by years of disaster drills at school, people from towns and villages along the coast — Japan's population is concentrated in an often narrow coastal plain — immediately fled to higher ground.

Japan is the only country on the planet with an earthquake early-warning system in place. It is also the only one with a truly

successful tsunami-alert scheme — 300 earthquake sensors scattered in territorial waters that can predict the likelihood of a tsunami in minutes. Tsunami evacuation routes are posted up and down the coast. When the government says to evacuate, the Japanese people listen.

## NEPAL-QUAKE

The 7.8 magnitude earthquake hampered Nepal for year. The earthquake that ravaged Nepal, killing at least 7200 people, has revealed the best and worst both in the Himalayan nation and those rushing to its aid. These 5 facts explain what's shaping the domestic and international responses to the 7.8 magnitude earthquake, and where Nepal goes from here.

### 1. A Quick Aid

Aid pledges are pouring in: \$10 million from the US, \$7.6 million from the UK, and \$3.9 million from Australia, among others. But as welcome as this influx of funds is, the sad reality is that Nepal is ill-equipped to make full use of these resources. That is why countries are lining up to donate technical expertise via disaster response teams as well. China has sent a 62-member search-and-rescue team to help the recovery effort. Israel has sent 260 rescue experts in addition to a 200-person strong medical team, while Japan has sent another 70 people as part of a disaster relief team. The United Nations, in addition to releasing \$15 million from its central emergency-response fund, is busy trying to coordinate international efforts to maximize their effectiveness.

### 2. A weak base

Nepal's infrastructure was critically feeble even before disaster struck. With per capita GDP less than \$700 a year, many Nepalese build their own houses

without oversight from trained engineers. Nepal tried to institute a building code in 1994 following another earthquake that claimed the lives of 700 people, but it turned out to be essentially unenforceable. To make matters worse, a shortage of paved roads in the country means that assistance can't reach remote regions where it's needed most. Local authorities are simply overwhelmed, as is Nepal's sole international airport in Kathmandu. Planes filled with blankets, food and medicine are idling on tarmacs because there are not enough terminals available.

### 3. Half a year's output gone?

The economic cost of the earthquake is estimated to be anywhere between \$1 billion to \$10 billion, for a country with an annual GDP of approximately \$20 billion. The economic impact will be lasting. Tourism is crucial to the Nepalese economy, accounting for about 8 percent of the total economy and employing more than a million people. Mount Everest, a dangerous destination under the best of circumstances, is the heart of that industry. The earthquake this past weekend triggered an avalanche that took the lives of at least 17 climbers, and as many as 200 people are still stranded on the mountain.

### 4. Internal political barriers

Nepal's domestic politics are not helping. Nepal's 1996-2006 civil war claimed the lives of at least 12,000 Nepalese, and the country's political system has never really recovered. The government that stood before the quake was woefully ill-prepared to deal with a disaster of such scale.

There have been no elections at the district, village or municipal level for nearly 20 years, and the committees in charge of local councils are not organized enough to deal with the difficult task of coordinating emergency assistance. Things are not much better at the national level, where

Kathmandu has seen nine prime ministers in eight years.

#### 5. *A competition for influence*

Not all foreign aid is altruistic, and some countries never miss an opportunity to capitalize on tragedy. For years, Nepal has been an object of competition between India and China. For India, Nepal has been a useful buffer state between itself and China ever since Beijing gained control over Tibet. Relative to China, India and Nepal are much closer linguistically and culturally. Nepalese soldiers train in India, and New Delhi is a main weapons supplier to Nepal. For China, Nepal is an important component of its "New Silk Road" plan to link Asia with Europe, and offers a useful

ally against Tibetan independence. China was already Nepal's biggest foreign investor as of 2014. While in the immediate aftermath of the earthquake both Asian powers are providing significant assistance, it's in the reconstruction phase where the true competition between the two will emerge. Pay particular attention to the race to build hydroelectric power plants: both Beijing and New Delhi have been positioning themselves to take advantage of Nepal's 6,000 rivers to feed their respective energy needs.

**Darshita Kathal**  
**2nd year, CSE**

*"We talk about restoration all the time, but people that don't work on it 24/7 think we're going to put it back like it was before. But it's not about that, it's about making it better going forward."*

# Credits

Dr. Rachna Chaturvedi

Faculty Incharge of Literary wing



(L->R)

First row:- Darshika Agarwal , Harshita Bhatt , Avni Malhotra ,  
Bhoomik Sharma , Tanya Arora , AishwayaDubey, Darshita Kathal

(L->R)

Second row:- Rajkumar Agarwal , Roopak Krishna , Asu Singh  
Ajay Singh , Aadish kr. Jain , Arjun Dua , Nabeel Faruqui  
Ishaan Joshi , Siddharth Sharma , Hrishi Jain